

OFFICE OF MANAGED  
SPACE FLIGHT

APOLLO PROGRAM

# PROJECT APOLLO COORDINATE SYSTEM STANDARDS

JUNE 1965

RECEIVED

MAR 2 1967

G.E. RAVERT



## APPROVED DATA

*503 & 504 only.*

NATIONAL AERONAUTICS AND SPACE ADMINISTRATION  
WASHINGTON, D.C. 20546

UNITED STATES GOVERNMENT

# Memorandum

National Aeronautics and  
Space Administration

M-C MA 1461

TO : Distribution

DATE: 1 Jun 1965

FROM : Apollo Program Director

SUBJECT: Project Apollo Coordinate System Standards

The document transmitted herewith contains the approved Coordinate System Standards for the Apollo Program.

The provisions of M-D MB 1400 (Apollo LV and SC Coordinate Axis and Notation System) dated June 1, 1964 are superseded by this document and all copies should be destroyed.

The provisions of M-DE 8000.006 (Mass Properties Standard) dated June 1, 1963 are consistent with this document.

The provisions of AFMTCM 80-4 (Air Force Missile Test Center Standardized Theoretical Trajectory Magnetic Tape Format) are unaffected by this document.

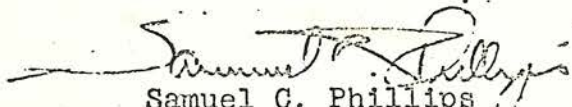
  
Samuel C. Phillips  
Major General, USAF

## Distribution

MSC/R. R. Gilruth (60)  
MSFC/W. von Braun (50)  
KSC/K. H. Debus (30)  
MAP/Col. M. L. Seccomb (2)  
MAS/T. H. Thompson (5)  
MAT/J. H. Disher (5)  
MAO/J. K. Holcomb (5)  
MAR/G. A. Lemke (5)  
MT/E. Z. Gray (5)  
Bellcomm/J. A. Hornbeck (25)  
MA-2/T. A. Keegan (2)



Buy U.S. Savings Bonds Regularly on the Payroll Savings Plan

PROJECT APOLLO COORDINATE  
SYSTEM STANDARDS

## ABSTRACT

This document contains the Project Apollo Coordinate System Standards (PACSS). It is the result of the combined efforts of representatives from GSFC, KSC, MSC, MSFC and Bellcomm. The standards are primarily derived from past common practice, provide a high degree of uniformity and are such that strict conformance is technically practical.

The majority of the Standard Coordinate Systems are associated with the Earth or Moon and have such uses as site location, ephemerides, trajectory computation and/or transmittal of trajectory information. The remaining Standard Coordinate Systems are referenced to the vehicles (both operating alone and in stacked configurations) or vehicle operations: primarily navigation, guidance and control. Additionally there are Standard Relationships which must exist among specific Standard Coordinate Systems.

All of the Project Apollo Coordinate System Standards (PACSS) are contained in the Appendices. The text provides amplification and explanation of the PACSS.

## TABLE OF CONTENTS

<u>Section</u>	<u>Title</u>	<u>Page</u>
	ABSTRACT	1
1.	INTRODUCTION	1
2.	APPROACH	2
2.1	General Coordinate Systems	2
2.2	Project Apollo Data	2
2.3	Project Apollo Decisions	4
3.	DISCUSSION OF PROJECT APOLLO COORDINATE SYSTEM STANDARDS	5
3.1	General Coordinate Systems Applied Directly to the Standards	5
3.2	Project Apollo Data Applied to the Standards	7
3.3	Project Apollo Decisions Applied to the Standards	9
3.3.1	Relationships Among Coordinate Systems Related to Apollo Navigation, Guidance and Control	10
3.3.2	Relationships Among the Structural Body Axes of the Apollo Vehicles	13
3.3.3	Relationships Among Coordinate Systems Under Backup Conditions	15
4.	SUMMARY	17
5.	GLOSSARY	18
6.	APPENDIX A: Project Apollo Standard Coordinate Systems	
7.	APPENDIX B: Project Apollo Standard Relationships Existing Among Standard Coordinate Systems	
8.	REFERENCES	

1.

## INTRODUCTION

On June 1, 1964, following more than a year of intercenter effort, an OMSF directive (M-D MB 1400) was issued establishing a standard vehicle coordinate system for Apollo. At the August 1964 Panel Review Board meeting it was found that the desired standardization had not in fact been accomplished by this directive. As a result a new effort was begun involving GSFC, KSC, MSC, MSFC and Bellcomm; the scope of this effort extended beyond vehicle axes and included all coordinate systems involved in Apollo interface data exchange. Complete involvement of the participating organizations was solicited so that the resulting standards would be the best possible set, worthy of unqualified adoption within Project Apollo and acceptable to all participants.

The resulting Project Apollo Coordinate System Standards (PACSS)\* are contained in this document. It has been organized such that all PACSS appear in the Appendices in concise language suited to literal interpretation. The body of the text attempts to define the approach and reveal underlying patterns among the coordinate systems.

In all applications the particular PACSS being used must be explicitly identified.

---

\*Users of AMR must submit data to the Range in a standardized format established by the Air Force Missile Test Center and described in Reference 1. These standards, which are outside NASA control, deviate from the PACSS in several instances.

2.

## APPROACH

This section is devoted to explaining the methods employed in the development of the Project Apollo Coordinate System Standards (PACSS) and thereby provides a means of understanding the logic of the approach. Basically a coordinate system provides a reference frame within which a physical problem is mathematically formulated and/or data are collected, analyzed or transmitted. The coordinate system chosen for use is usually selected based on the requirements of the specific problem. The Apollo project may be thought of as a collection of related problems, each with its own preferred reference frame. The purpose of this document is to establish a practical minimum number of well defined coordinate systems to be used for interface data exchange purposes. The Approach Diagram on page 3 represents the framework for the development of the PACSS and is explained in the following subsections.

2.1

### General Coordinate Systems

Past practice provided a wealth of coordinate systems from which appropriate selections were made for standardization in Project Apollo. Often the definitions were quite entangled with the specific functional use; separating them resulted in a group of general coordinate systems which were defined in a basic and fundamental manner. A number of these general coordinate systems were placed directly in the PACSS without elaboration. The remaining systems in the general grouping required further definition in order to be useful.

2.2

### Project Apollo Data

Certain of the general coordinate systems were not immediately applicable to Project Apollo, simply because of the excessively general nature of their definition. With the introduction of specific Apollo physical data the ambiguity present in many of these definitions was removed and they became acceptable as Apollo Standard Coordinate Systems. However, a few coordinate systems still required additional information before they became applicable.

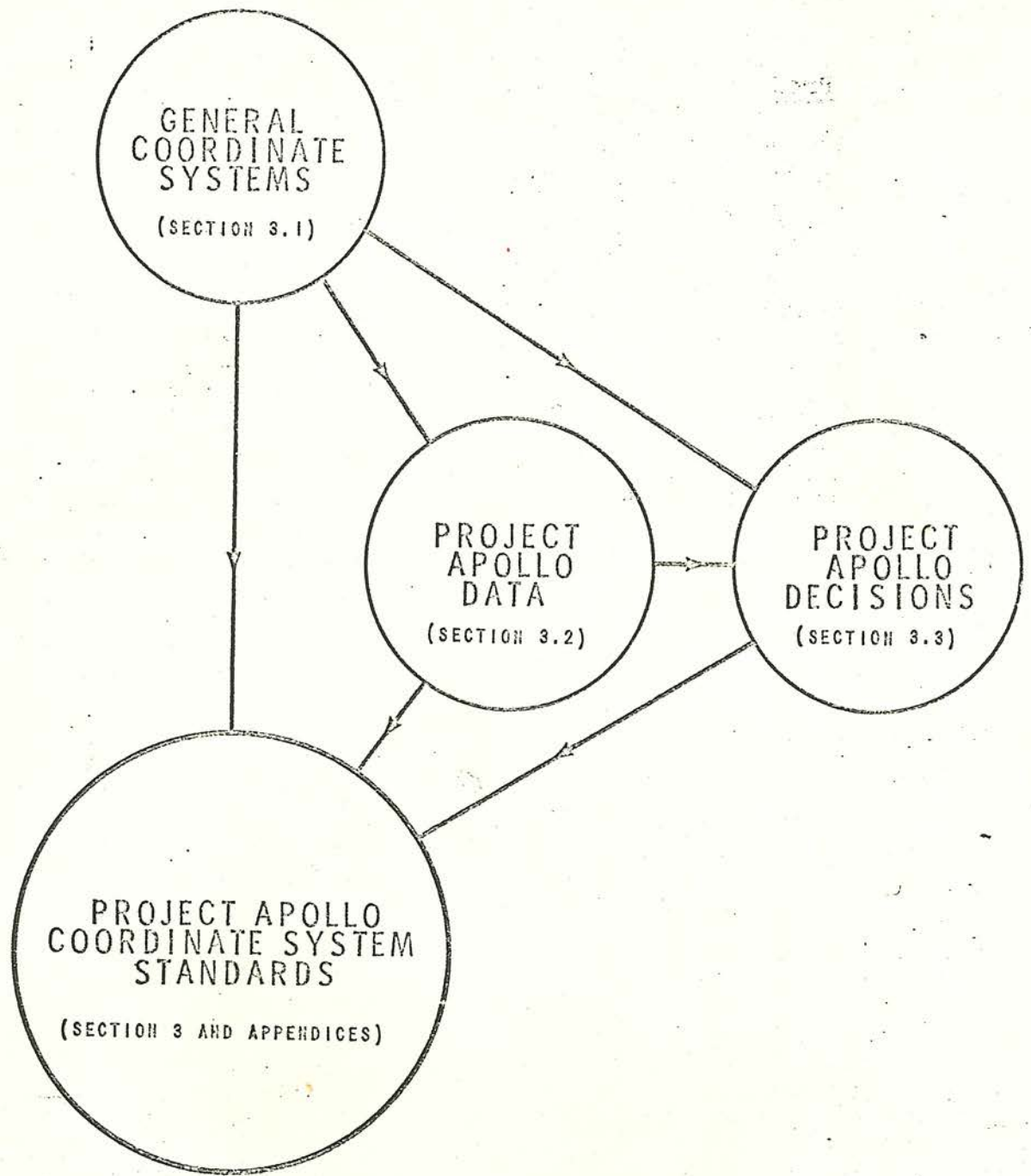

APPROACH DIAGRAM



2.3

Project Apollo Decisions

Adequate definition of the remaining coordinate systems was attained by incorporating information concerning specific Apollo project decisions. Generally these decisions consisted of ground rules and constraints relating to the use of the Standard Coordinate Systems. Furthermore, by recording Standard Relationships which must exist among certain coordinate systems during various phases of the mission, additional standards were created. Consequently, there is a meaningful distinction between a Standard Coordinate System and a Project Apollo Coordinate System Standard (PACSS); the latter is the general category and includes the former.

3. DISCUSSION OF PROJECT APOLLO COORDINATE SYSTEM STANDARDS

The complete set of Project Apollo Coordinate System Standards are contained in the Appendices. The discussion in this section is keyed to the Approach Diagram (page 3) and presents additional information concerning these coordinate system standards. The Appendices consist almost entirely of figures, generally one standard per figure. Figures A-1 through A-13 in Appendix A define Project Apollo Standard Coordinate Systems. Figures B-1 through B-3 in Appendix B define Standard Relationships among two or more Standard Coordinate Systems; in each of these cases the relationship itself is an Apollo Standard. In the following discussion frequent reference will be made to these figures.

A tabulation of the general coordinate systems to be applied to Project Apollo is presented in Table I, page 6. These systems have been subdivided for convenience according to whether they are rotating or non-rotating with respect to space-direction fixed axes and according to the body to which they are referenced, i.e., Earth, Moon, or vehicle. Table I contains only the standardized names of the coordinate systems and is introduced here to establish perspective.

3.1 General Coordinate Systems Applied Directly to the Standards

There are a number of the general coordinate systems shown in Table I which can be applied directly to Project Apollo without further information or modification, specifically:

Geographic Polar	Figure A-1
Selenographic Polar	Figure A-2
Radar	Figure A-3 (a through d)
Geocentric Inertial	Figure A-4

TABLE I

TABULATION OF GENERAL COORDINATE SYSTEMS

THE CENTER OF THE COORDINATE SYSTEM IS REFERENCED TO THE:			
	VEHICLE	EARTH	MOON
THE AXES OF THE COORDINATE SYSTEM ARE:	ROTATING	<ul style="list-style-type: none"> <li>○ GEOGRAPHIC POLAR</li> <li>○ RADAR</li> <li>○ EARTH-FIXED LAUNCH SITE</li> <li>○ EARTH-CENTERED LAUNCH DERIVED</li> </ul>	<ul style="list-style-type: none"> <li>○ SELENOGRAPHIC POLAR</li> </ul>
	NON-ROTATING	<ul style="list-style-type: none"> <li>○ PLATFORM-ACCELEROMETER</li> </ul>	<ul style="list-style-type: none"> <li>○ GEOCENTRIC INERTIAL</li> <li>○ IMPACT PREDICTION QUASI-INERTIAL</li> <li>○ EARTH-MOON PLANE</li> <li>○ ORBITAL ELEMENTS</li> <li>○ NAVIGATION</li> </ul>

Impact Prediction Quasi-Inertial	Figure A-5
Earth-Moon Plane	Figure A-6
Orbital Elements	Figure A-7

It is interesting to note that all of these systems are either Earth or Moon Referenced. The remaining systems listed in Table I require additional project information in order to become well-defined standards.

### 3.2 Project Apollo Data Applied to the Standards

The definitions of the Standard Coordinate Systems introduced in this section are completed by the application of specific Apollo data to the rotating vehicle referenced coordinate systems of Table I which are otherwise ambiguous.

The general standard for the Structural Body Axes\* system (Figure 1, page 8) only specifies that the X axis lies along the vehicle longitudinal axis, the origin is located with respect to a reference point on the longitudinal axis and the Z axis is defined by a vehicle benchmark. Thus, in order to obtain each specific Project Apollo standard it was necessary to define the hardware-related origin of the system and the appropriate benchmark defining the positive Z axis for each of the Apollo vehicles. The Structural Body Axes systems for the Apollo vehicles are:

#### A. Launch Vehicles

##### 1. Saturn I and IB (Figure A-8a).

The origin is located on the longitudinal axis 100 inches below the gimbals reference plane. Position I (alternatively, fin I) defines the positive Z direction.

---

\*The Dynamical Body Axes system for any configuration is obtained by a pure translation of the appropriate Structural Body Axes system to the instantaneous center of mass of that configuration (see Section 3.3.2).

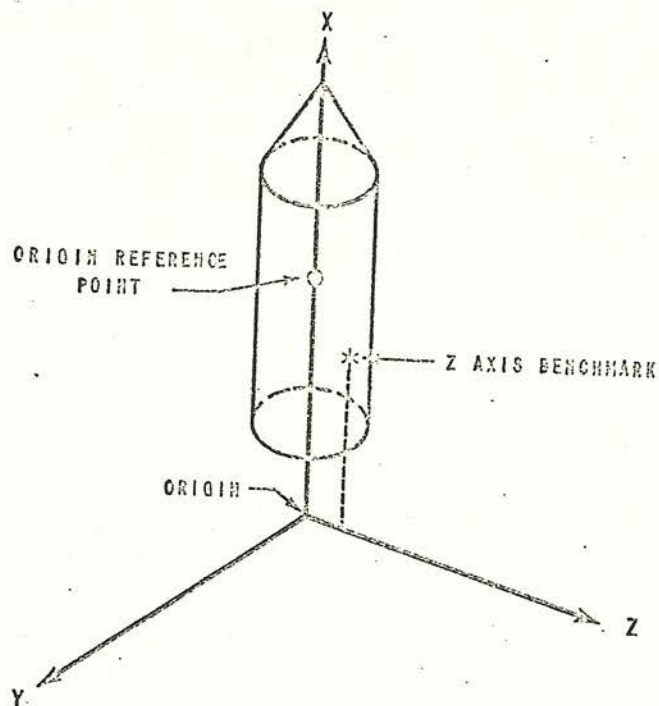

TYPE: Rotating, vehicle referenced

ORIGIN: Located on the vehicle's longitudinal axis and defined with respect to a specified reference point, which is fixed relative to the vehicle structure.

#### ORIENTATION AND LABELING

The X axis lies along the longitudinal axis of the vehicle, positive in the nominal direction of positive thrust acceleration.

The Z axis is perpendicular to the X axis and lies in the plane defined by the X axis and a specified vehicle benchmark, positive toward the benchmark.

The Y axis completes a standard right-handed system.

The Dynamical Body Axes system is defined as a pure translation of the Structural Body Axes system to the instantaneous vehicle center of gravity.

Figure 1 STRUCTURAL BODY AXES (Dynamical Body Axes)

## 2. Saturn V (Figure A-8b).

The origin is located on the longitudinal axis 100 inches below the gimbal reference plane. Position I defines the positive Z axis.

### B. Command and Service Module (Figure A-8c)

The origin is located on the longitudinal axis 1000 inches below the mold line of the CSM heat shield main structure ablator interface. The benchmark defining the positive Z axis is an alignment target (labeled +Z) at the top of the service module.

### C. Lunar Excursion Module (Figure A-8d)

The origin is located 200 inches below the LEM Ascent stage base. The positive Z axis is not defined by a physical benchmark; however, the center of the LEM exit hatch serves as a reference benchmark. Thus the positive Z axis is parallel to the center line of the exit hatch.

The Mass Properties system (Figure A-9), in which the mass characteristics of the space vehicle and its systems, subsystems and components are described, is consistent in axes orientation and labeling with the CSM Structural Body Axes. The origin of this system is not specified uniquely; thus, for interchange of mass property data, it is essential that the origin be explicitly stated.\*

## 3.3

### Project Apollo Decisions Applied to the Standards

This section is primarily concerned with the description and/or specification of Standard Relationships which exist among various members of the Apollo Standard Coordinate Systems. In the development of these Standard Relationships, which arise from basic project decisions, the four general coordinate systems remaining in Table I are introduced and defined.

---

\*The origin for CSM and LEM mass data is the same as for the CSM Structural Body Axes. The origin for the launch vehicle is the same as for the launch vehicle Structural Body Axes.

### 3.3.1

#### Relationships Among Coordinate Systems Related to Apollo Navigation, Guidance and Control

Several interrelationships exist among the coordinate systems involved in the navigation, guidance and control functions; these interrelationships are basically the same for the Launch Vehicle, CSM, CM and LEM. The Dynamical Body Axes, Platform-Accelerometer and Navigation coordinate systems are common to all powered flight phases and these are discussed first. Several additional systems which apply only during the launch phase are treated later.

The Dynamical Body Axes system of a particular vehicle is always translatable with its Structural Body Axes system. Consistent use of the standard axes designations results in a "normally expected" orientation of the vehicle with respect to the flight path. For example, in the Launch Vehicle and CSM the axes commonly termed pitch\*, roll and yaw are identical with the y, x and z directions, respectively. This is not so in the LEM because the pitch, roll and yaw designations (y, z, x, respectively) have been assigned in a manner which is consistent with astronaut orientation rather than one which is consistent with common vehicle practice.

The Platform-Accelerometer system is used for vehicle attitude reference and to define the orientation of the accelerometers. The orientation of the Platform-Accelerometer system is determined at the time of erection of the platform. Gimbal angles relate the position of the Dynamical Body Axes to this space-direction fixed system.

The Navigation system has its origin centered in a specified (usually the dominant) central body and is translatable with the Platform-Accelerometer system for computational convenience. Specific operational orientations for the Platform-Accelerometer and Navigation coordinate systems will vary throughout the Mission.

---

\*Because of the inconsistent definitions of pitch, roll and yaw with respect to the x, y and z Body Axes systems, it is recommended that these terms not be depended upon to define directions of vehicle or platform axes.

The Dynamical Body Axes, Platform-Accelerometer and Navigation systems have interrelated roles during powered flight. The rules for the operational use of these systems are generally such as to keep them all as nearly in alignment as possible during any powered flight interval. A typical relative alignment of these three systems is shown for the spacecraft in Figure 2 (page 12), where the central body pictured is the Moon. The Platform-Accelerometer system is aligned with the X axis in the general direction of positive thrust (typically this may be either the initial or average thrust direction for the burn). The Y axis direction is defined by the vector cross product of the positive X axis into the vehicle position vector; the Z axis completes a standard right handed system.

The relative alignment of these three systems is basically the same for the launch vehicle as for the spacecraft. However, the Platform-Accelerometer Y axis becomes ill defined for the Earth launch since the thrust vector (X axis) and the position vector are nearly colinear. Therefore, at launch the Platform-Accelerometer axes are defined with the X axis along the local reference ellipsoid normal\*, positive outward and the Z axis in the plane defined by the X axis and aiming azimuth, positive down range.

Similarly, when launching from the Moon the LEM Platform-Accelerometer system is aligned with the X axis along a reference vertical and the Z axis in the direction of the aiming azimuth.

For the launch phase, conditions are sufficiently invariant from mission to mission that specific standards can be defined. The following four Standard Coordinate Systems are associated with launch vehicle navigation, guidance and control.

Earth-Fixed Launch Site	Figure A-10
Earth-Centered Launch Derived	Figure A-11
Launch Vehicle Platform- Accelerometer	Figure A-12
Launch Vehicle Navigation	Figure A-13

---

\*The reference ellipsoid is chosen to best fit the geoid or some portion of it; the Apollo standard is the 1960 Fischer ellipsoid.



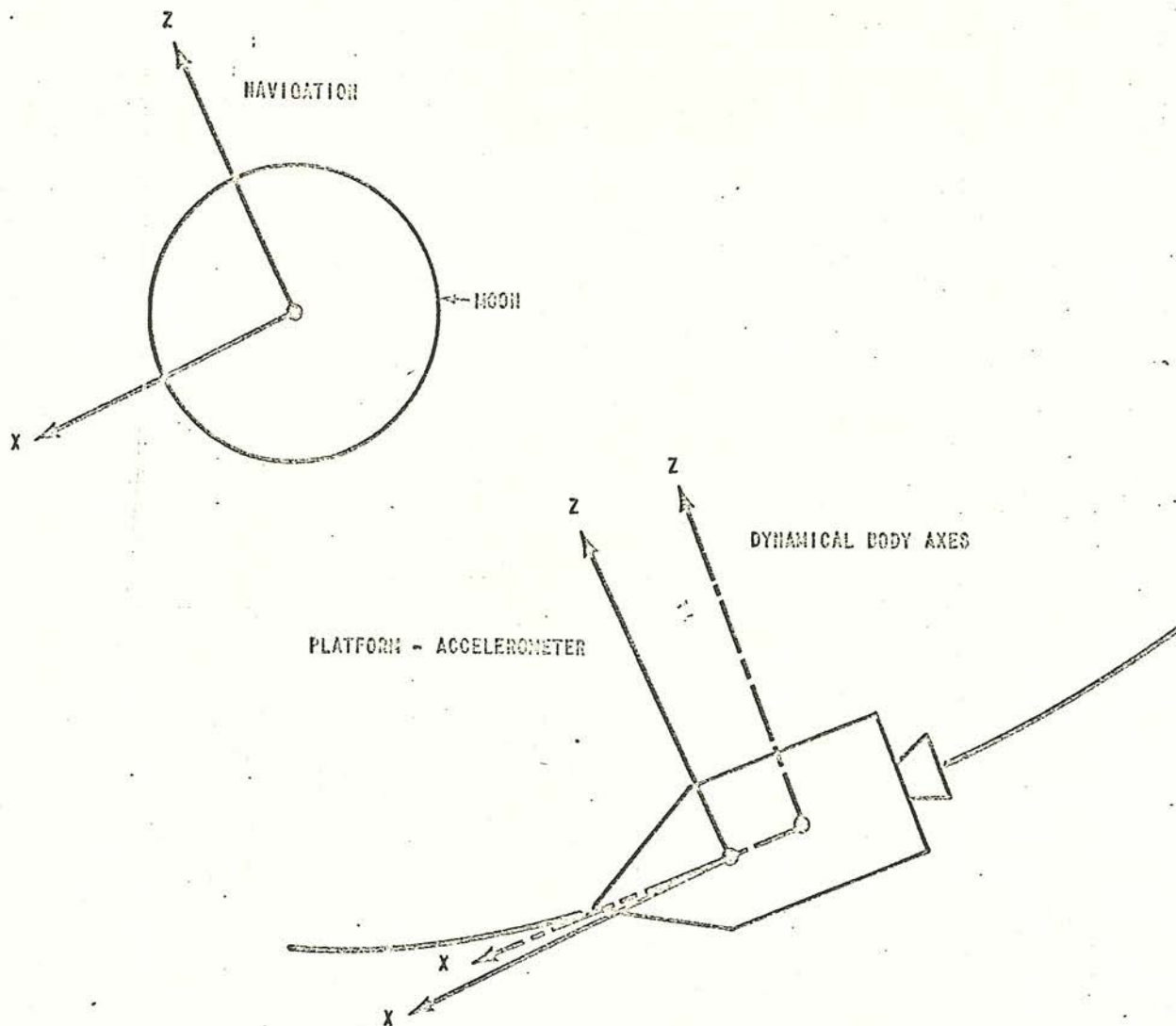

NOTE: COORDINATE SYSTEMS WHICH ARE TRANSLATABLE HAVE BEEN DRAWN WITH A SOLID LINE.

FIGURE 2 RELATIONSHIPS OF SPACECRAFT DYNAMICAL BODY AXES, PLATFORM-ACCELEROMETER AND NAVIGATION COORDINATE SYSTEMS (SIMPLIFIED PLANAR VIEW)

The Earth-Fixed Launch Site system is rotating with the Earth and oriented in the direction of launch. It is expressed in terms of the reference ellipsoid and requires an exact specification of both the launch site location and the aiming azimuth for the trajectory. This system leads to the definition of the Launch Vehicle Platform-Accelerometer system at guidance reference release time when the gyros are uncaged and the stable platform becomes space-direction fixed. The Earth-Centered Launch Derived system is defined to be translatable at all times with the Earth-Fixed Launch Site system. The Launch Vehicle Navigation system is in turn defined to be identical to the Earth-Centered Launch Derived system at guidance reference release time. Thus, two rotating systems, the Earth-Fixed Launch Site and the Earth-Centered Launch Derived, give rise to two non-rotating systems, the Launch Vehicle Platform-Accelerometer and the Launch Vehicle Navigation at guidance reference release time. A typical relative alignment of the systems in this category is shown in Figure 3 (page 14).

### 3.3.2

#### Relationships Among the Structural Body Axes of the Apollo Vehicles

The Structural Body Axes systems as assigned in section 3.2 exhibit a common property, which is illustrated in Figure B-1\*. Here the three Apollo vehicles are shown side by side, each in its preferred powered flight attitude. Each vehicle, if operating independently, would choose this orientation to lift off and proceed down range in the positive Z direction. This Standard Relationship results from previous common practice, including pilot orientation with respect to the flight path (see Reference 3).

There are two separate multi-vehicle configurations in Project Apollo. The first occurrence is at Earth launch, where the Standard Relationship between the Structural Body Axes of the three vehicles is as shown in Figure B-2\*.

---

\*The Structural Body Axes are the subjects of discussion; however, to preserve clarity, the Dynamical Body Axes are pictured in this figure. The Structural and Dynamical Body Axes are translatable.

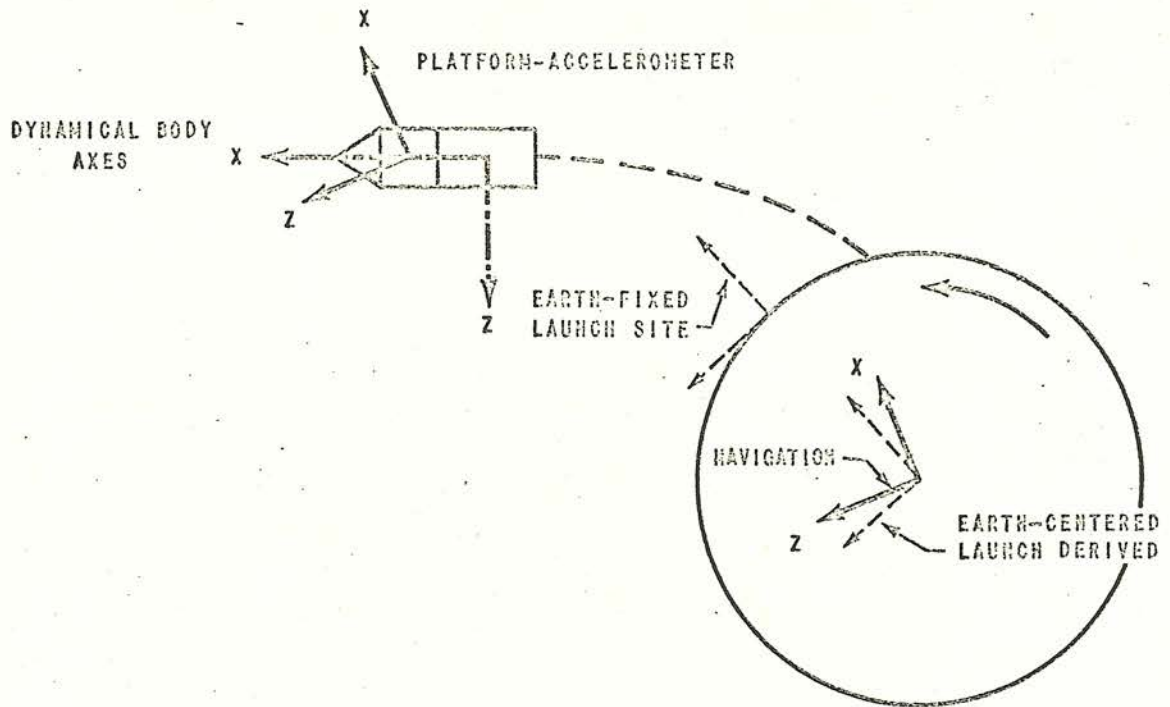

NOTE: THE AXES ORIENTATION OF THE PLATFORM-ACCELEROMETER AND NAVIGATION SYSTEMS ARE DEFINED BY THE EARTH-FIXED LAUNCH SITE AND EARTH-CENTERED LAUNCH DERIVED SYSTEMS AT GUIDANCE REFERENCE RELEASE TIME.

COORDINATE SYSTEMS WHICH ARE TRANSLATABLE ARE DRAWN WITH THE SAME TYPE LINE (SOLID OR DASHED).

FIGURE 3 EARTH LAUNCH RELATED COORDINATE SYSTEMS  
(PICTURED FOR A LAUNCH FROM THE EQUATOR INTO AN EQUATORIAL ORBIT)

The second is the normal docked configuration of the CSM/LEM spacecraft. The assignment of the Structural Body Axes for each individual vehicle is independent of its position in either of the stacked configurations. The implicit decision is that the standardization of coordinate systems for the individual vehicles is basically more important than having all coordinate systems translatable either at launch or in the docked configuration\*. This is equivalent to treating the inactive vehicles as an inert payload.

A Structural Body Axes coordinate system can be defined for each multi-vehicle stack. The Standard Relationship defining this coordinate system requires that it be identical with the Structural Body Axes system of the primary or thrusting vehicle. Thus the space vehicle Structural Body Axes system shown in Figure B-3 is the same as that of the launch vehicle. For a multi-vehicle configuration, the origin of the Dynamical Body Axes is located at the center of mass of the configuration and not at the center of mass of the primary (thrusting) vehicle.

### 3.3.3

#### Relationships Among Coordinate Systems Under Backup Conditions

The pattern of the PACSS is such as to keep the separate vehicles autonomous and the coordinate systems consistent from vehicle to vehicle. It is thus necessary to carefully define the appropriate coordinate systems to be used when a multi-vehicle configuration exists. For the Structural Body Axes systems it has already been stated in section 3.3.2 that the coordinate system for any stack shall be that of the primary or thrusting vehicle, all other vehicles being considered inert. In cases where backup guidance must be ready to take over at any time, specific ground rules are necessary. The following simple rules provide consistent relations among the coordinate systems under backup guidance situations.

---

\*It should be noted that the individual vehicle coordinate systems could not have been assigned in any way that would allow them to be translatable for both stacked configurations.

- o The backup Platform-Accelerometer coordinate system shall be translatable with that of the primary.
- o The Dynamical Body Axes of the primary (thrusting) vehicle shall always be used, i.e. steering commands shall be transmitted in the coordinate system of the primary vehicle regardless of the source.

4.

SUMMARY

The Project Apollo Coordinate System Standards consist of the following kinds of information:

- o definition of Standard Coordinate Systems consisting of
  - a. a descriptive name
  - b. position of the origin
  - c. orientation, positive direction and labeling of the axes
  - d. a time derivative notation
- o definition of Standard Relationships existing among Standard Coordinate Systems

All PACSS are contained in the Appendices; in general, one standard per page. There are twelve Standard Coordinate Systems (Figures A-1 through A-7 and A-10 and A-11) referenced to the Earth or Moon and generally applicable in defining positions and/or velocities of sites, vehicles and other bodies. Seven Standard Coordinate Systems (Figures A-8 and A-9 and A-12 and A-13) are related to the specific vehicles and vehicle dynamics including navigation, guidance and control. The standardization of relationships (Figures B-1 through B-3) is primarily among systems in this latter group.

The most important underlying pattern in the standards is the use of the same basic coordinate system definitions for each vehicle including its navigation, guidance and control. Multi-vehicle and/or backup situations are controlled through the definition of Standard Relationships among the coordinate systems associated with the individual vehicles. Practical control of all such situations is not possible by standardization alone and thus normal practice should include identification of the standard coordinate system being used and/or configuration sketches.

5.

GLOSSARY

REFERENCE ELLIPSOID is an ellipsoid chosen to best fit the geoid or some portion of it. For the Earth, an oblate spheroid is normally used. The Apollo standard is the 1960 Fischer ellipsoid. More detailed information is available in Reference 2.

REFERENCED, as used in describing a coordinate system, indicates the body with which the origin of the system is associated. This terminology is used in preference to the word "fixed" which connotes a rigid attachment of the coordinate system to the associated body. For example, the Geographic Polar system defined with respect to the prime meridian and the equatorial plane is rigidly "fixed" in the Earth; whereas, the Geocentric Inertial system defined with respect to the vernal equinox and the equatorial plane is not "fixed" in the Earth but is referenced to it.

ROTATING is used to indicate coordinate systems whose axes exhibit angular motion with respect to space fixed directions. There are no constraints on the motion of the origin of such a system.

NON-ROTATING is used to indicate coordinate systems whose axes exhibit no angular motion with respect to space fixed directions. However, there are no constraints on the motion of the origin of such a system.

TRANSLATABLE coordinate systems have the property that similarly labeled axes are parallel and have the same positive directions.

6.

APPENDIX A

Project Apollo Standard Coordinate Systems

This Appendix contains the figures depicting the nineteen Standard Coordinate Systems. In the use of these standards, the dot convention for indicating time derivatives shall be adhered to when appropriate.



LIST OF PROJECT APOLLO STANDARD

COORDINATE SYSTEMS

<u>Figure</u>	<u>Title</u>
A-1	Geographic Polar
A-2	Selenographic Polar
A-3a	Radar (AZ-EL)
A-3b	Radar (HA-DEC)
A-3c	Radar (X-Y 30 ft.)
A-3d	Radar (X-Y 85 ft.)
A-4	Geocentric Inertial
A-5	Impact Prediction Quasi-Inertial
A-6	Earth-Moon Plane
A-7	Orbital Elements
A-8a	Saturn I and IB Launch Vehicle Structural Body Axes
A-8b	Saturn V Launch Vehicle Structural Body Axes
A-8c	CSM Structural Body Axes
A-8d	LEM Structural Body Axes
A-9	Mass Properties
A-10	Earth-Fixed Launch Site
A-11	Earth-Centered Launch Derived
A-12	Launch Vehicle Platform-Accelerometer
A-13	Launch Vehicle Navigation

# STANDARD COORDINATE SYSTEM 1

## GEOGRAPHIC POLAR

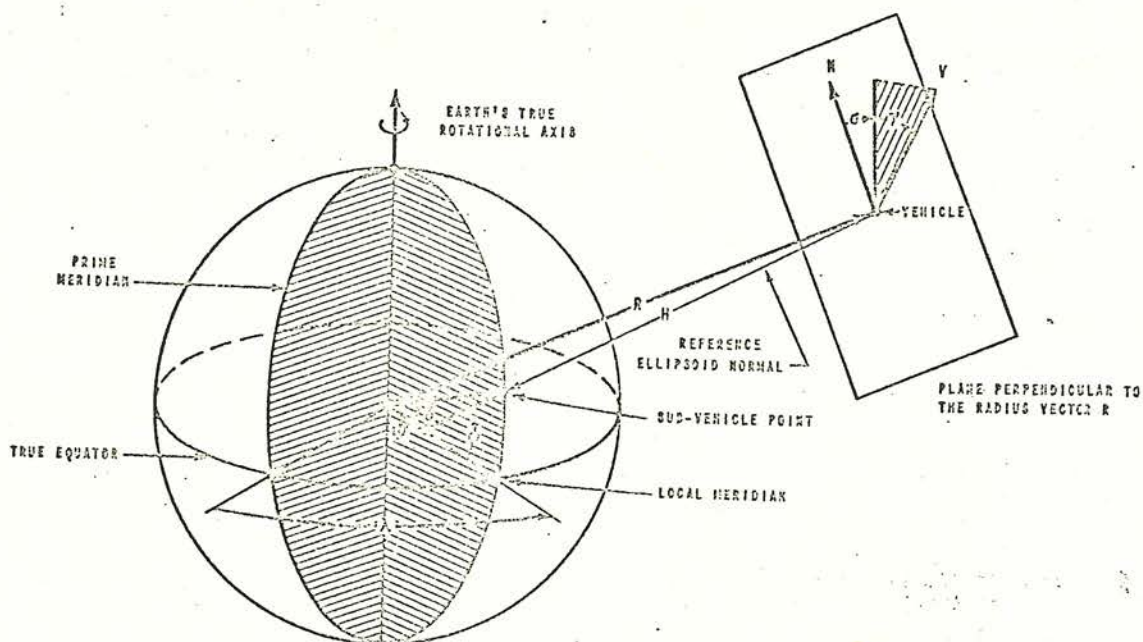

TYPE: Rotating, Earth referenced

ORIGIN: The center of the Earth

### ORIENTATION AND LABELING:

$\lambda$  is the longitude measured positive eastward from the prime (Greenwich) meridian to the meridian containing the point of interest.

$\delta$  is the geocentric declination (angle between the geocentric radius vector and the true equatorial plane) measured positive north and negative south of the true equatorial plane.

The geodetic latitude  $\phi$  is the angle defined by the intersection of the reference ellipsoid normal through the point of interest and the true equatorial plane, positive north and negative south of the true equatorial plane.

The geocentric latitude  $\psi$  is the angle between the true equatorial plane and the radius vector to the point of intersection of the reference ellipsoid and the reference ellipsoid normal passing through the point of interest, measured positive north and negative south of the true equatorial plane.

The altitude  $H$  is the perpendicular distance from the reference ellipsoid to the point of interest.

$R$  is the magnitude of the geocentric radius vector to the point of interest.

$V$  is the magnitude of the velocity (inertial or Earth-fixed) of the vehicle.

$\sigma$  is the azimuth from north of the velocity vector projected on a plane normal to the geocentric radius vector to the vehicle.

$\gamma$  is the flight path angle measured positive upward to the velocity vector from the plane normal to the geocentric radius vector.

Subscripts are used to distinguish between the Earth-fixed and the inertial quantities. Specifically  $V_E$ ,  $\sigma_E$  and  $\gamma_E$  define the Earth-fixed velocity and  $V_I$ ,  $\sigma_I$  and  $\gamma_I$  define the inertial velocity.

FIGURE A-1



STANDARD COORDINATE SYSTEM 3a

RADAR (AZ-EL)

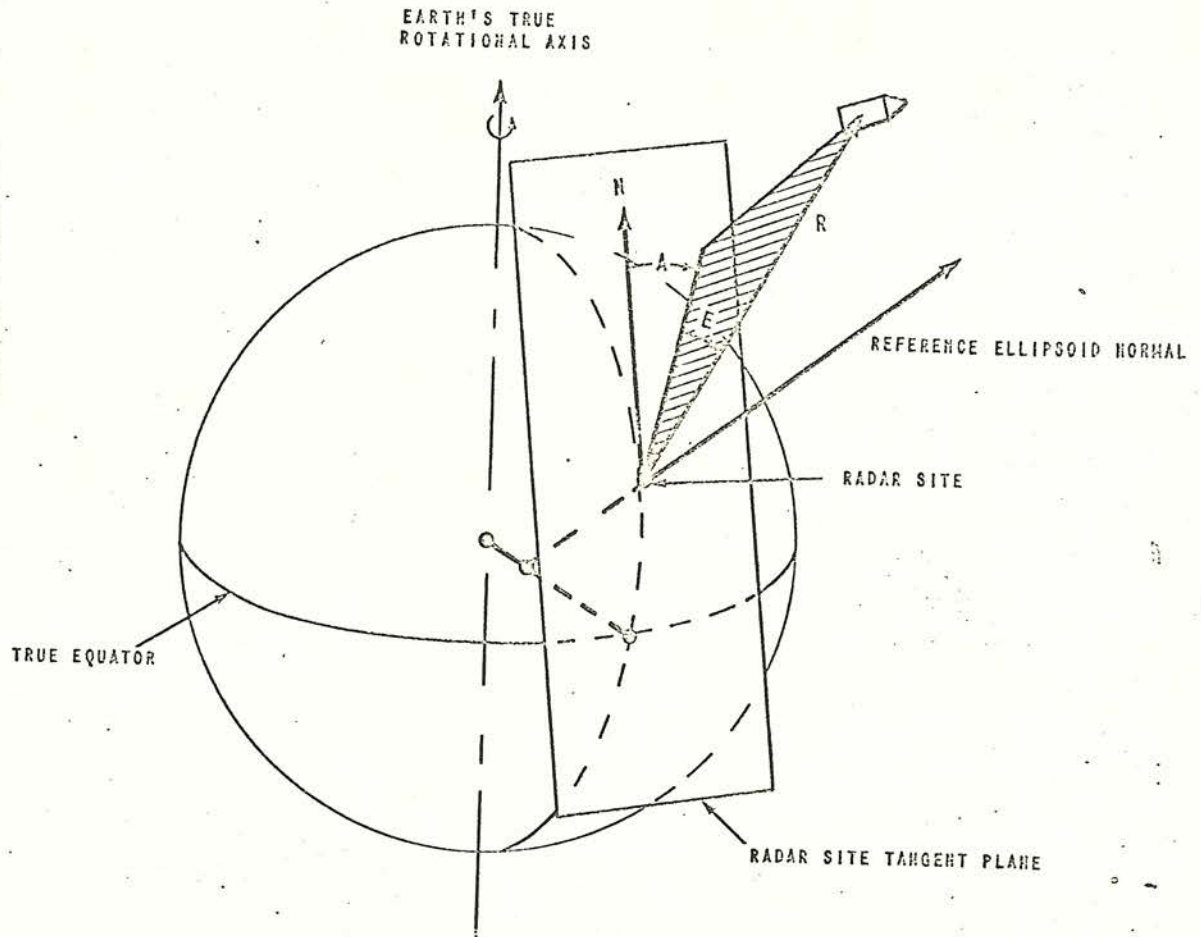

TYPE: Rotating, Earth referenced

ORIGIN: The intersection of the radar axes

ORIENTATION AND LABELING:

The radar site tangent plane contains the site and is perpendicular to the reference ellipsoid normal which passes through the radar site.

R is the slant range to the vehicle.

A is the azimuth angle measured clockwise from true north to the projection of the slant range vector onto the radar site tangent plane.

E is the elevation angle measured positive above the radar site tangent plane to the slant range vector.

FIGURE A-3a

# STANDARD COORDINATE SYSTEM 3b

## RADAR (HA-DEC)

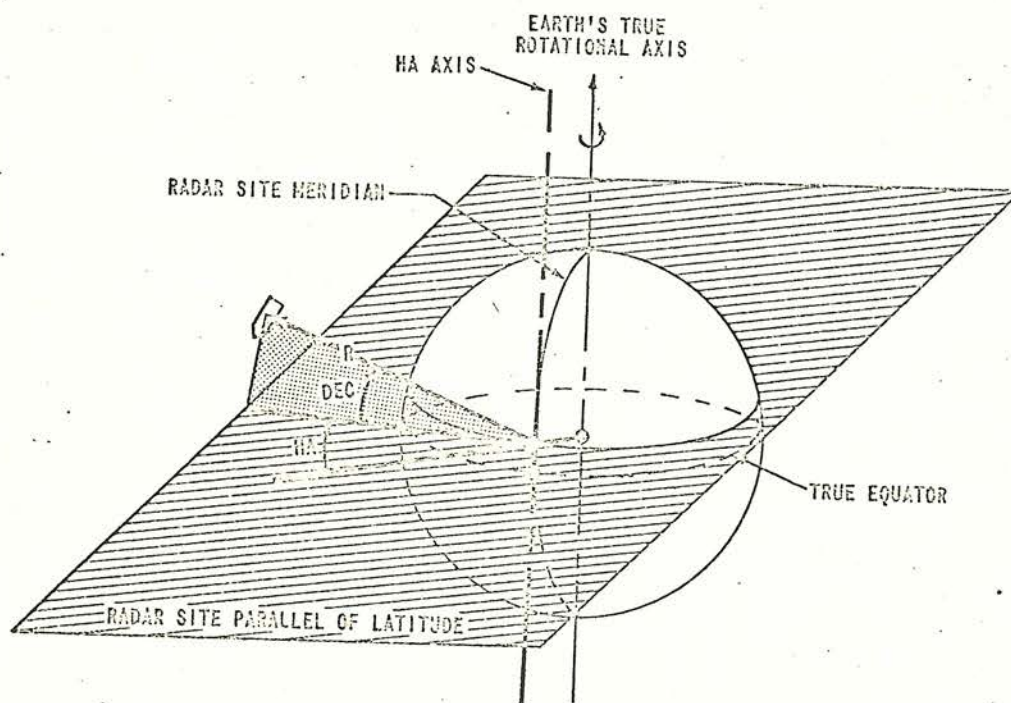

TYPE: Rotating, Earth referenced

ORIGIN: The point of intersection of the hour angle axis with the plane of the declination gear

### ORIENTATION AND LABELING:

R is the slant range\* to the vehicle.

The HA axis is parallel to the Earth's true rotational axis. The declination axis is parallel to the true equator and perpendicular to the HA axis.

The hour angle (HA) is measured positive westward in the plane of the local radar site parallel of latitude, from the radar site meridian plane to the plane perpendicular to the equator and containing the vehicle and the radar site.

The declination (DEC) is the angle measured from the radar site parallel of latitude to the vehicle, positive north and negative south of this plane.

\* Range rate (R) data is also generally available in this system.

FIGURE A-3b

STANDARD COORDINATE SYSTEM 3c

RADAR (X-Y 30 ft.)

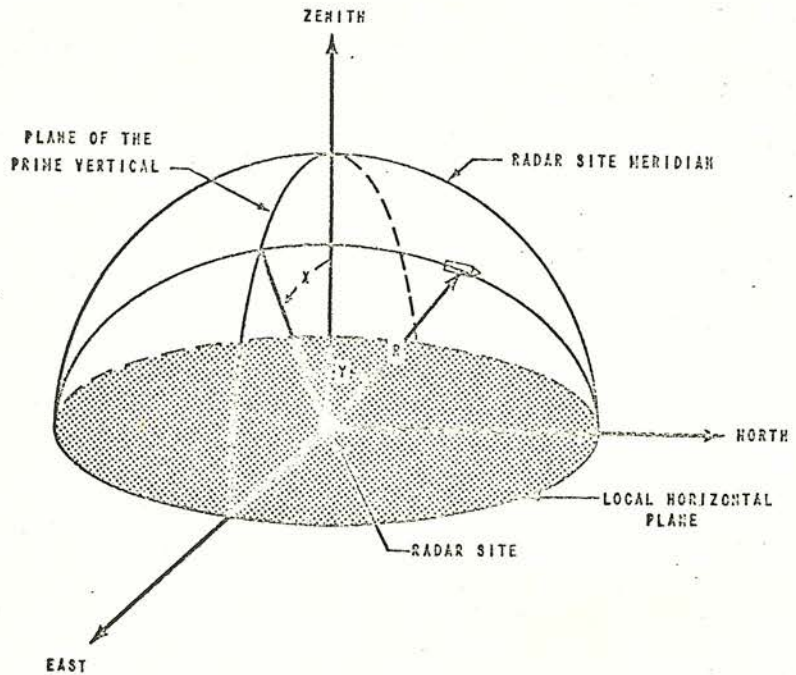

TYPE: Rotating, Earth referenced

ORIGIN: At the intersection of the X axis and the plane of the Y axis gear

ORIENTATION AND LABELING:

R is the slant range\* from the radar site to the vehicle.

The X axis lies along the intersection of the horizontal plane and the meridian plane at the radar site. The Y axis is perpendicular to the X axis.

X is the angle measured in the plane of the radar site prime vertical from the zenith to the projection of the slant range vector, onto this plane, positive eastward.

Y is the angle between the slant range vector and its projection onto the plane of the radar site prime vertical, positive when the slant range vector is north of the plane and negative when it is south of it.

(When the radar antenna is directed toward the zenith, the X and Y angles are zero and the Y axis is perpendicular to the radar site meridian plane.)

\*Range rate ( $\dot{R}$ ) data is also generally available in this system.

FIGURE A-3c

STANDARD COORDINATE SYSTEM 3d

RADAR (X-Y 85 ft.)

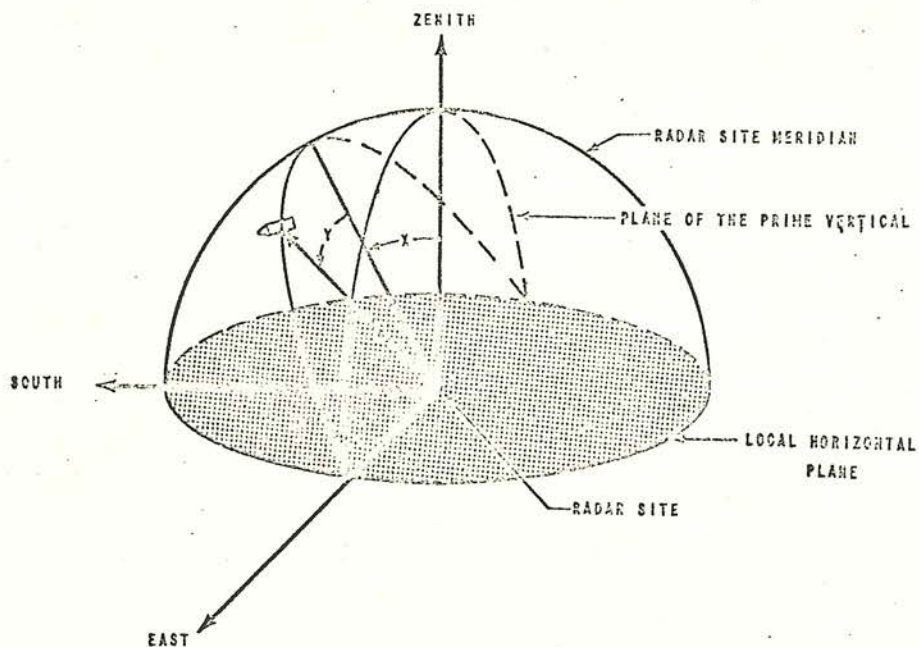

TYPE: Rotating, Earth referenced

ORIGIN: At the intersection of the X axis and the plane of the Y axis gear

ORIENTATION AND LABELING:

R is the slant range\* from the radar site to the vehicle.

The X axis lies along the intersection of the horizontal plane and the plane of the prime vertical at the radar site. The Y axis is perpendicular to the X axis.

X is the angle measure in the meridian plane of the radar site from the zenith to the projection of the slant range vector onto this plane, positive southward.

Y is the angle between the slant range vector and its projection onto the meridian plane of the radar site, positive when the slant range vector is east of the meridian plane and negative when it is west of it.

(When the radar antenna is directed toward the zenith, the X and Y angles are zero and the Y axis is perpendicular to the radar site prime vertical plane.)

\* Range rate ( $\dot{R}$ ) data is also generally available in this system.

FIGURE A-3d

STANDARD COORDINATE SYSTEM 4  
GEOCENTRIC INERTIAL

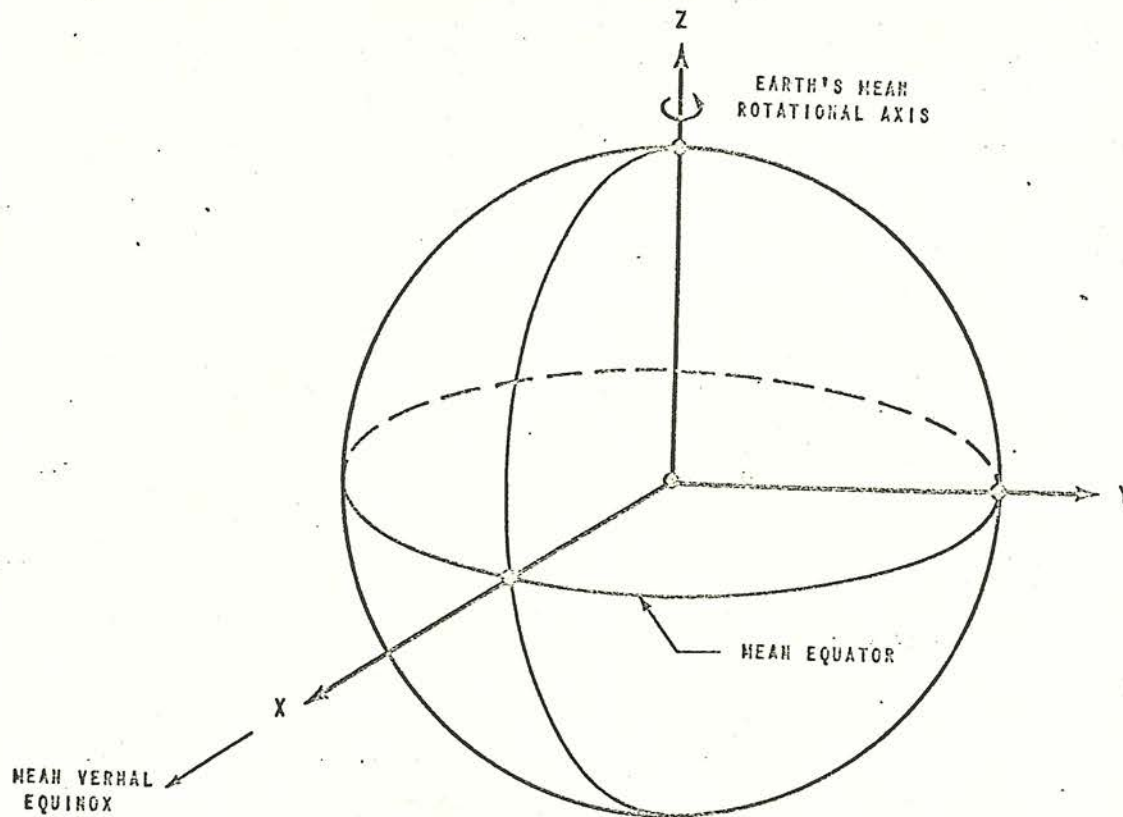

TYPE: Non-rotating, Earth referenced

ORIGIN: The center of the Earth

ORIENTATION AND LABELING:

The Z axis is directed along the Earth's mean rotational axis, positive north.

The X axis is directed toward the mean vernal equinox.

The Y axis completes a standard right-handed system.

The epoch will generally be the nearest beginning of a Besselian year. However, special applications may involve other epochs. Consequently, in any transmission of related data, the reference epoch used should be clearly stated.

This system is translatable to a Selenocentric Inertial system.

FIGURE A-4



STANDARD COORDINATE SYSTEM 5  
IMPACT PREDICTION QUASI-INERTIAL

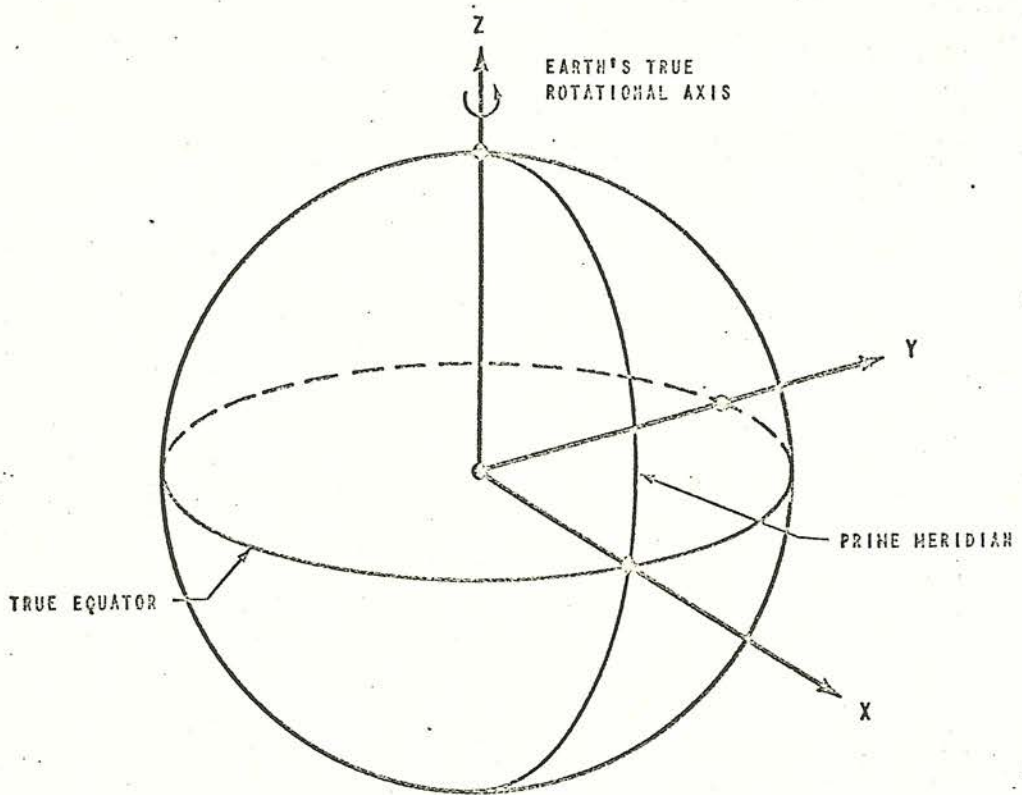

TYPE: Non-rotating, Earth referenced

ORIGIN: The center of the Earth

ORIENTATION AND LABELING:

This system is redefined at the beginning of each computational cycle. It is an inertial system\* for the duration of each computational cycle.

The Z axis is along the Earth's true rotational axis, positive north.

The positive X axis intersects the prime (Greenwich) meridian at the beginning of each computational cycle.

The Y axis completes a standard right-handed system.

(The X-Y plane is the Earth's true equatorial plane.)

---

\*Velocities expressed in this system are inertial velocities.

FIGURE A-5

STANDARD COORDINATE SYSTEM 6  
EARTH-MOON PLANE

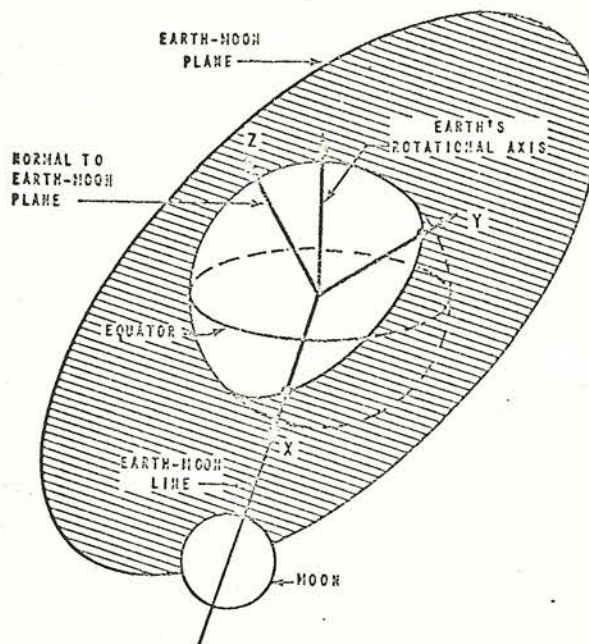

TYPE: Non-rotating

ORIGIN: The center of the specified central body  
(Earth or Moon: The Earth-centered system  
is shown in this Figure.)

ORIENTATION AND LABELING:

This system is redefined at the beginning of each computational cycle. It is an inertial system\* for the duration of each computational cycle.

The X axis lies along the Earth-Moon line at the beginning of each computational cycle, positive away from the Earth toward the Moon.

The Z axis is normal to the Earth-Moon plane, and parallel to the Moon's angular momentum vector, positive in a northerly direction.

The Y axis completes a standard right-handed system.

(The X-Y plane is normal to the Moon's angular momentum vector.)

This system is translatable to a selenocentric Earth-Moon Plane system. In this case the positive X axis lies along the extended Earth-Moon line and is directed away from the Earth.

\* Velocities expressed in this system are inertial velocities.

FIGURE A-6

# STANDARD COORDINATE SYSTEM 7 ORBITAL ELEMENTS

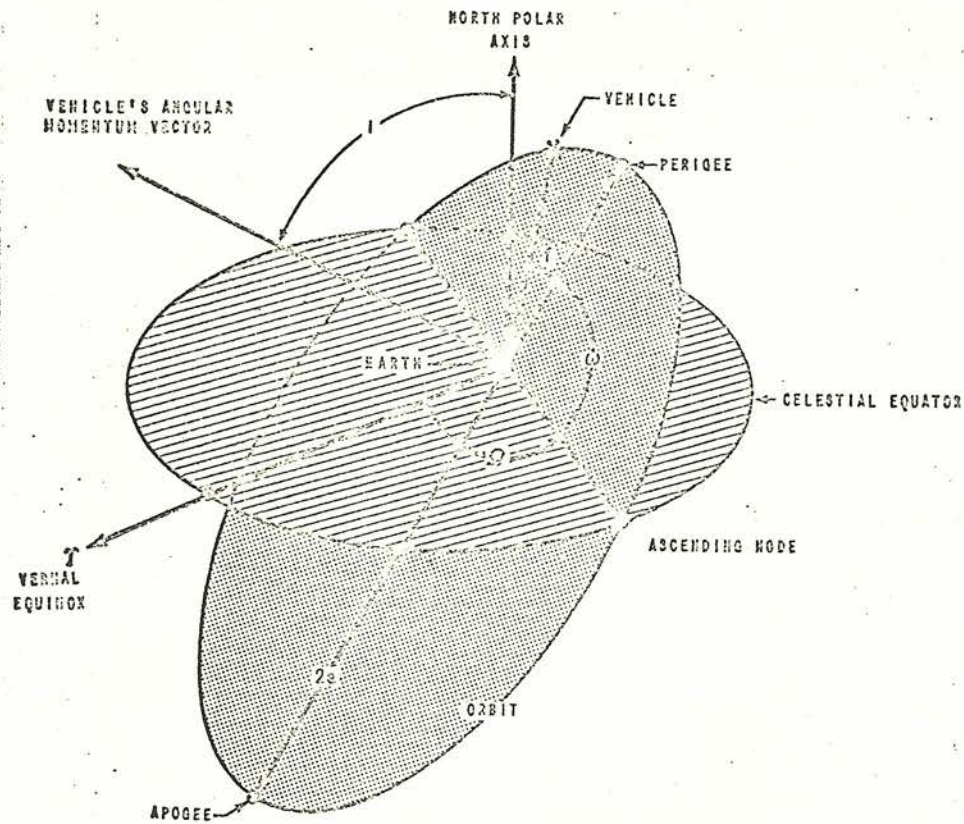

TYPE: Non-rotating, Earth referenced

ORIGIN: The center of the Earth

### ORIENTATION AND LABELING:

$a$  is the semi-major axis of the orbit.

$e$  is the eccentricity of the orbit.

$f$ , the true anomaly, is the geocentric angular displacement of the vehicle measured in the orbit plane from perigee, positive in the direction of travel in the orbit.

$\Omega$ , the right ascension of the ascending node, is the angle measured eastward from the vernal equinox along the equator to that intersection with the orbit where the vehicle passes from south to north.

$\omega$ , the argument of perigee, is the angle measured in the orbit plane between the ascending node and perigee, positive in the direction of travel in the orbit.

$i$ , the inclination of the orbital plane, is the angle between the north polar axis and the vehicle angular momentum vector.

FIGURE A-7

STANDARD COORDINATE SYSTEM 8a  
 SATURN I AND IB LAUNCH VEHICLE STRUCTURAL BODY AXES

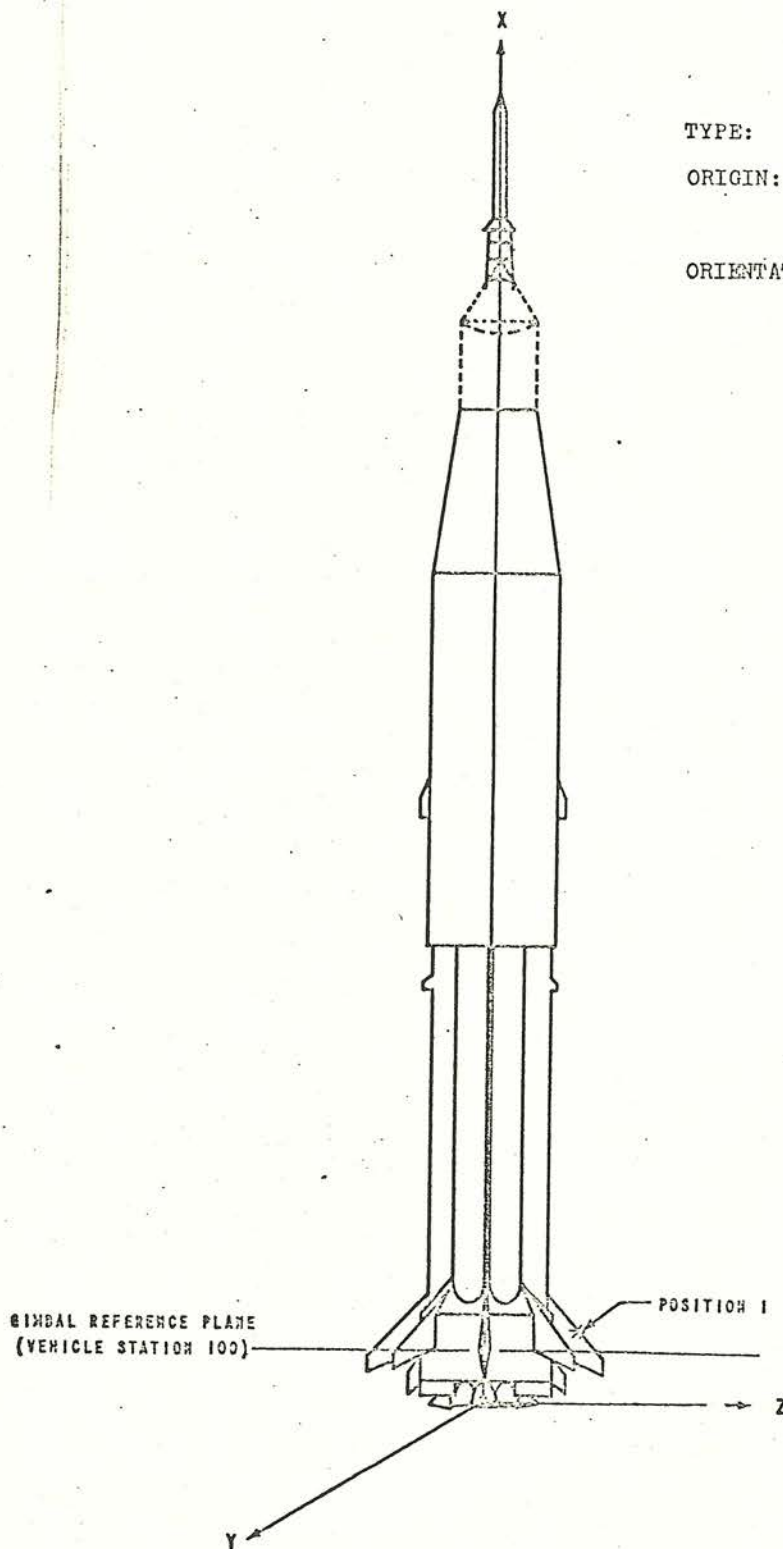

TYPE: Rotating, vehicle referenced  
 ORIGIN: On the longitudinal axis, 100 inches below the gimbal reference plane

ORIENTATION AND LABELING:

The X axis lies along the longitudinal axis of the vehicle, positive in the nominal direction of positive thrust acceleration.

Position I (alternatively fin I) defines the positive Z direction.

The Y axis completes a standard right-handed system.

The Dynamical Body Axes system, which has its origin at the vehicle's instantaneous center of mass, is translatable with the Structural Body Axes system.

Launch Complexes 34 and 37 will be used for Saturn I and IB launchings. The positive Z axis of the erected vehicle will be directed approximately  $100^{\circ} 12'$  east of north for Launch Complex 34, and approximately  $90^{\circ} 12'$  east of north for Launch Complex 37.

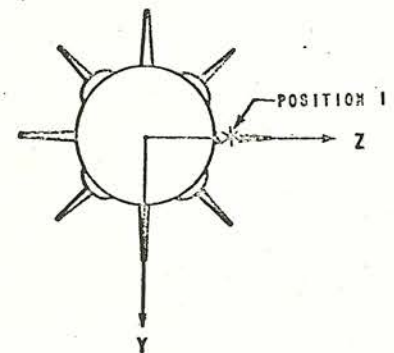

TOP VIEW

FIGURE A-8a

STANDARD COORDINATE SYSTEM 8b  
 SATURN V LAUNCH VEHICLE STRUCTURAL BODY AXES

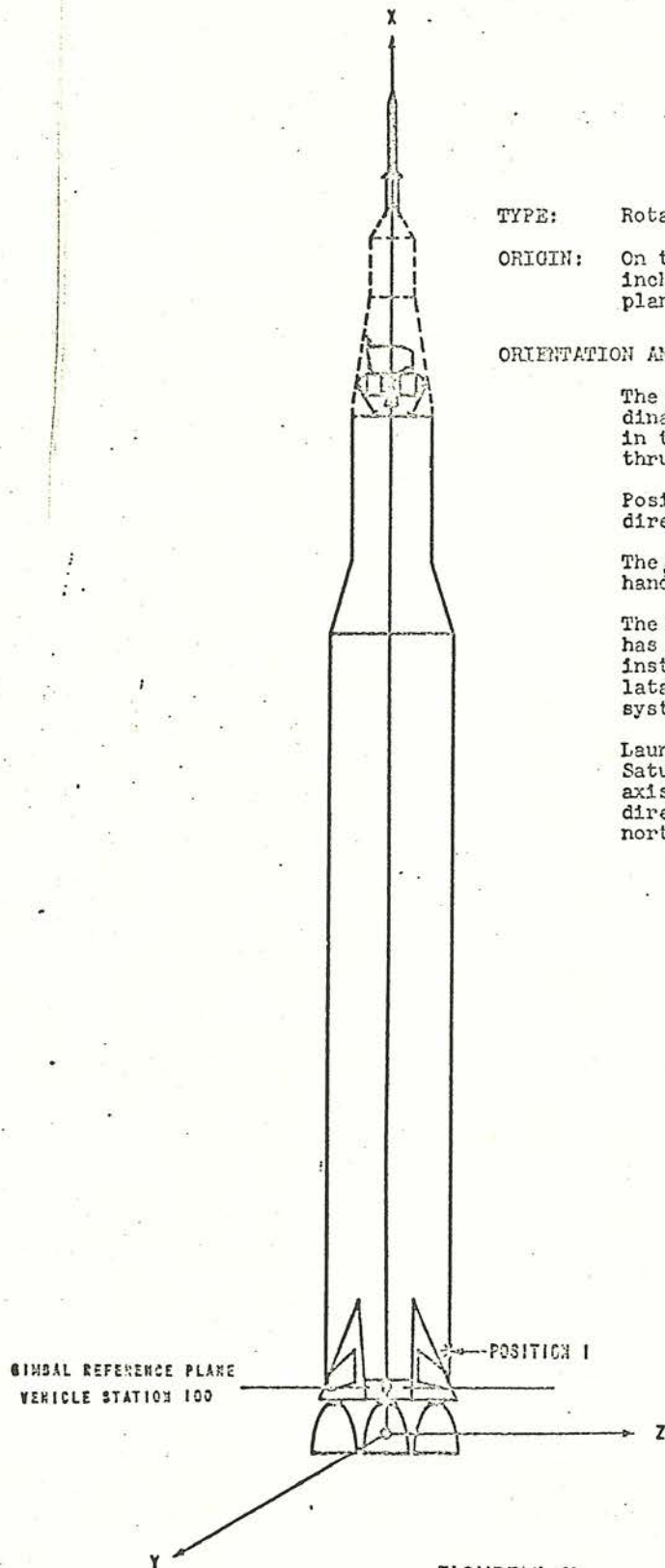

TYPE: Rotating, vehicle referenced  
 ORIGIN: On the longitudinal axis, 100 inches below the gimbals reference plane

ORIENTATION AND LABELING:

The X axis lies along the longitudinal axis of the vehicle, positive in the nominal direction of positive thrust acceleration.

Position I defines the positive Z direction.

The Y axis completes a standard right-handed system.

The Dynamical Body Axes system, which has its origin at the vehicle's instantaneous center of mass, is translatable with the Structural Body Axes system.

Launch Complex 39 will be used for Saturn V launchings. The positive Z axis of the erected vehicle will be directed approximately  $90^{\circ} 12'$  east of north for this launch complex.

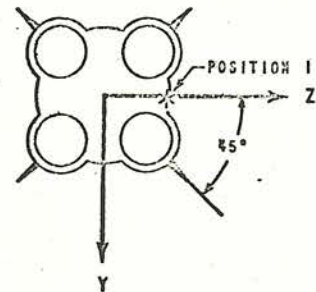

TOP VIEW

FIGURE A-8b

STANDARD COORDINATE SYSTEM 8c  
CSM STRUCTURAL BODY AXES

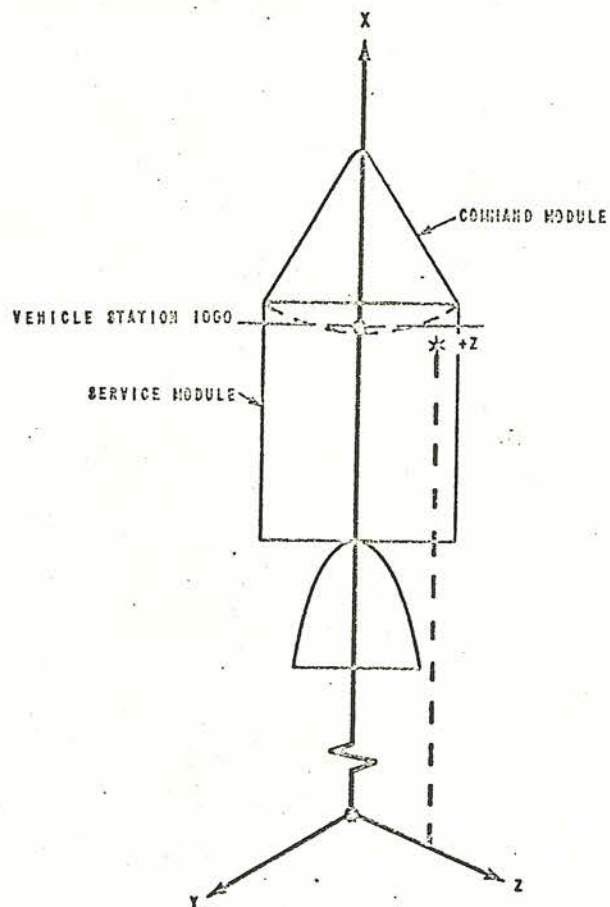

**TYPE:** Rotating, vehicle referenced

**ORIGIN:** On the longitudinal axis, 1,000 inches below the mold line of the heat shield main structure ablator interface.

**ORIENTATION AND LABELING:**

The X axis lies along the longitudinal axis of the vehicle, positive in the nominal direction of positive thrust acceleration.

The benchmark defining the positive Z axis is an alignment target (labeled +Z) at the top of the service module.

The Y axis completes a standard right-handed system.

The dynamical Body Axes system, which has its origin at the vehicle's instantaneous center of mass, is translatable with the Structural Body Axes system.

FIGURE A-8c

STANDARD COORDINATE SYSTEM 8d  
LEM STRUCTURAL BODY AXES

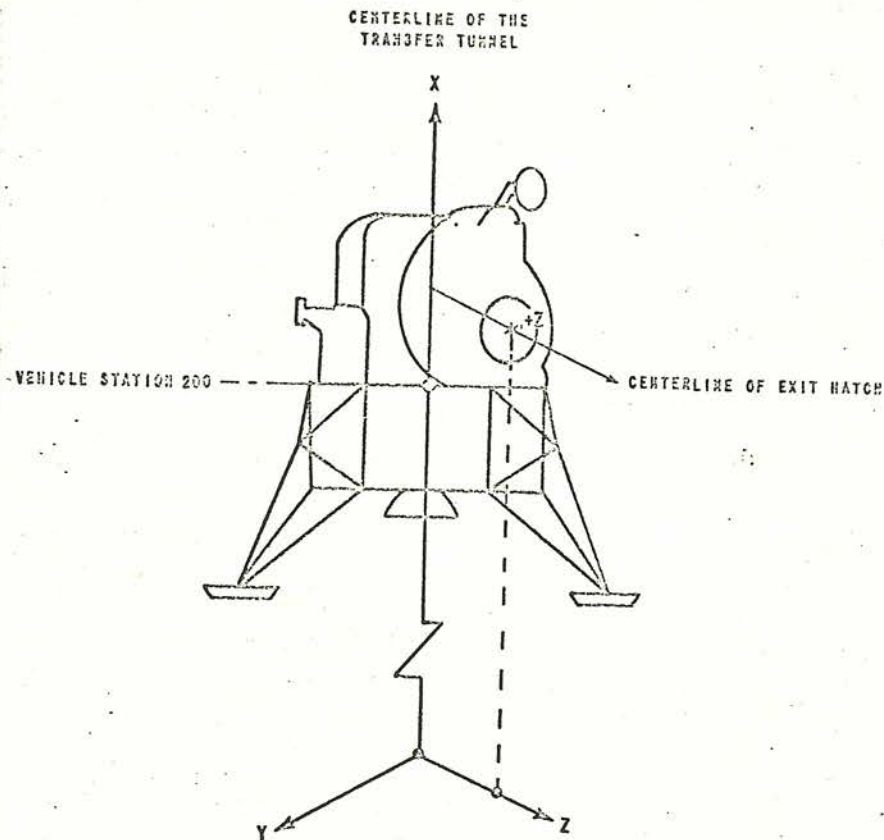

TYPE: Rotating, vehicle referenced

ORIGIN: Located 200 inches below the LEM Ascent stage base

ORIENTATION AND LABELING:

The X axis lies along the longitudinal axis (centerline of the transfer tunnel) of the LEM, positive in its nominal direction of positive thrust acceleration.

The positive Z axis is not defined by a physical benchmark; however, the center of the LEM exit hatch serves as a reference benchmark. Thus, the positive Z axis is parallel to the centerline of the exit hatch.

The Y axis completes a standard right-handed system.

The Dynamical Body Axes system, which has its origin at the vehicle's instantaneous center of mass, is translatable with the Structural Body Axes system.

FIGURE A-8d

STANDARD COORDINATE SYSTEM 9  
MASS PROPERTIES

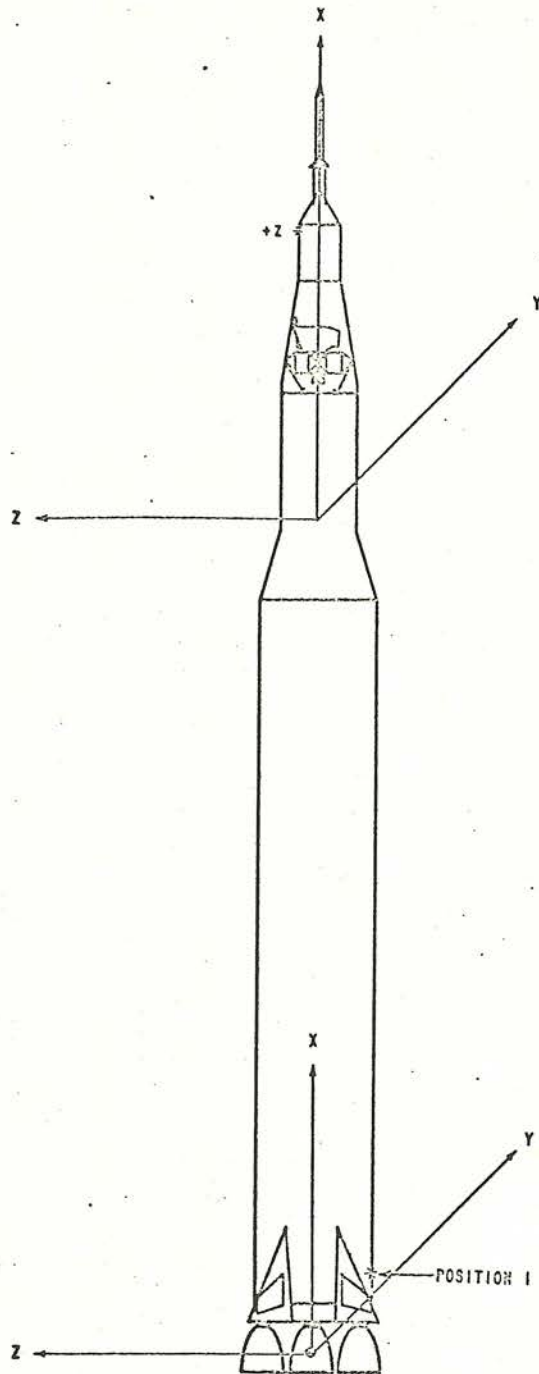

TYPE: Rotating, vehicle referenced

ORIGIN: Two origin are employed with this system: one coincides with the origin of the Launch Vehicle Structural Body Axes system and the other coincides with the origin of the CSM Structural Body Axes system. The former is generally used when transmitting launch vehicle mass properties data and the latter when transmitting spacecraft mass properties data.

ORIENTATION AND LABELING

In all cases the orientation and labeling of the axes is identical with that of the CSM Structural Body Axes system (Standard Coordinate System 8c).

FIGURE A-9



STANDARD COORDINATE SYSTEM 10  
EARTH-FIXED LAUNCH SITE

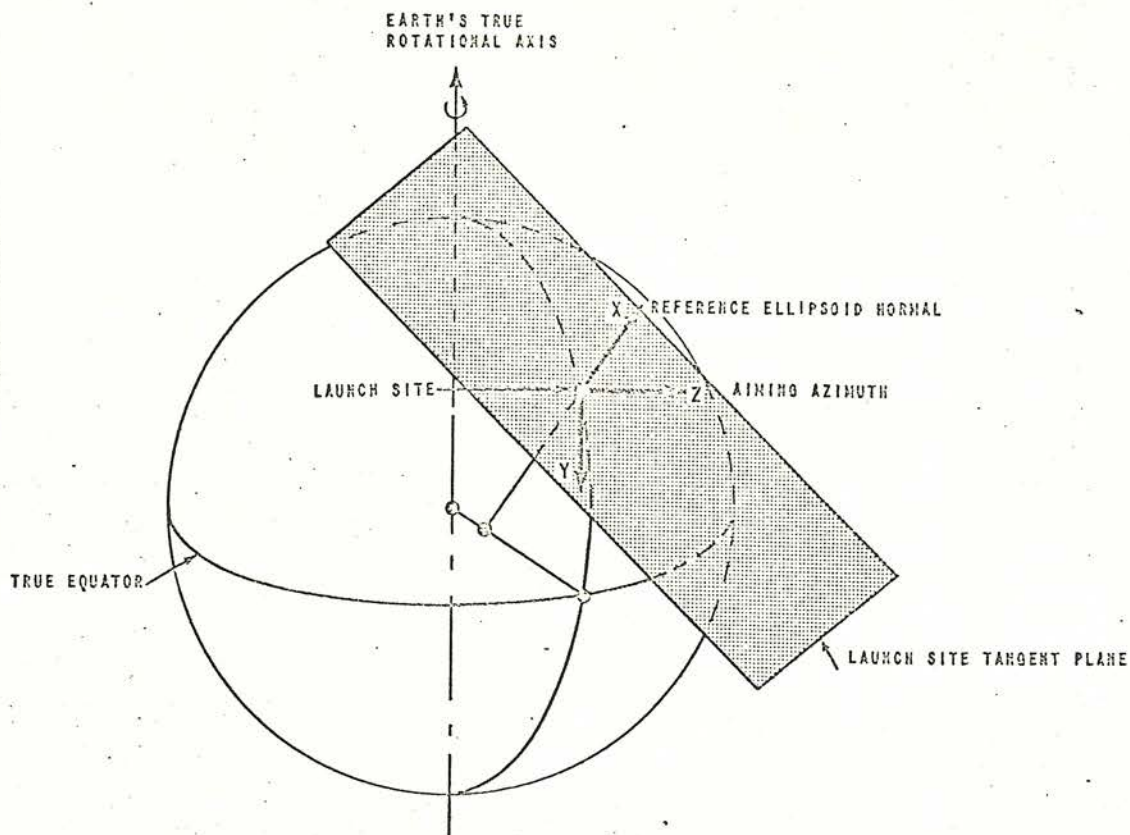

TYPE: Rotating, Earth referenced

ORIGIN: At the intersection of the reference ellipsoid and the normal to it which passes through the launch site.

ORIENTATION AND LABELING:

The launch site tangent plane contains the site and is perpendicular to the reference ellipsoid normal which passes through the launch site.

The X axis coincides with the reference ellipsoid normal passing through the site, positive upward.

The Z axis is parallel to the Earth-fixed aiming azimuth, defined at guidance reference release time, and is positive downrange.

The Y axis completes a standard right-handed system.

(The Y-Z plane is the launch site tangent plane.)

FIGURE A-10

STANDARD COORDINATE SYSTEM 10  
EARTH-FIXED LAUNCH SITE

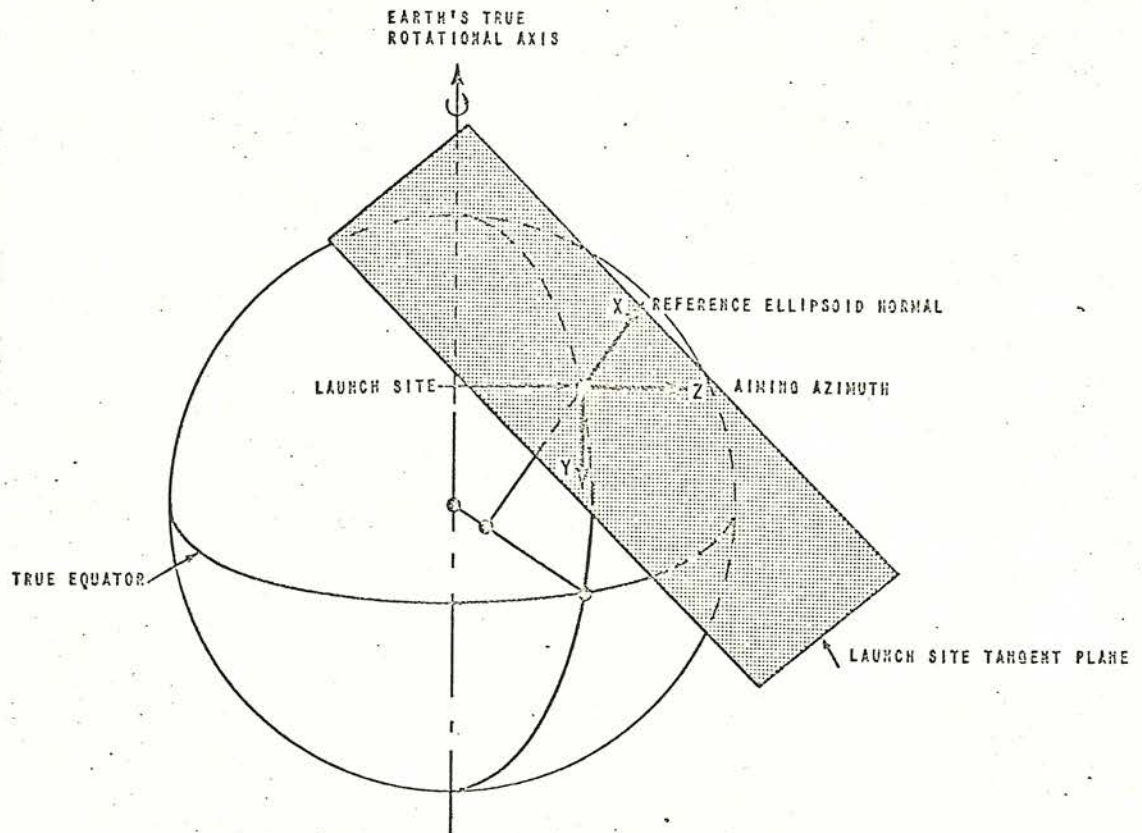

TYPE: Rotating, Earth referenced

ORIGIN: At the intersection of the reference ellipsoid and the normal to it which passes through the launch site.

ORIENTATION AND LABELING:

The launch site tangent plane contains the site and is perpendicular to the reference ellipsoid normal which passes through the launch site.

The X axis coincides with the reference ellipsoid normal passing through the site, positive upward.

The Z axis is parallel to the Earth-fixed aiming azimuth, defined at guidance reference release time, and is positive downrange.

The Y axis completes a standard right-handed system.

(The Y-Z plane is the launch site tangent plane.)

FIGURE A-10

STANDARD COORDINATE SYSTEM 11  
EARTH-CENTERED LAUNCH DERIVED

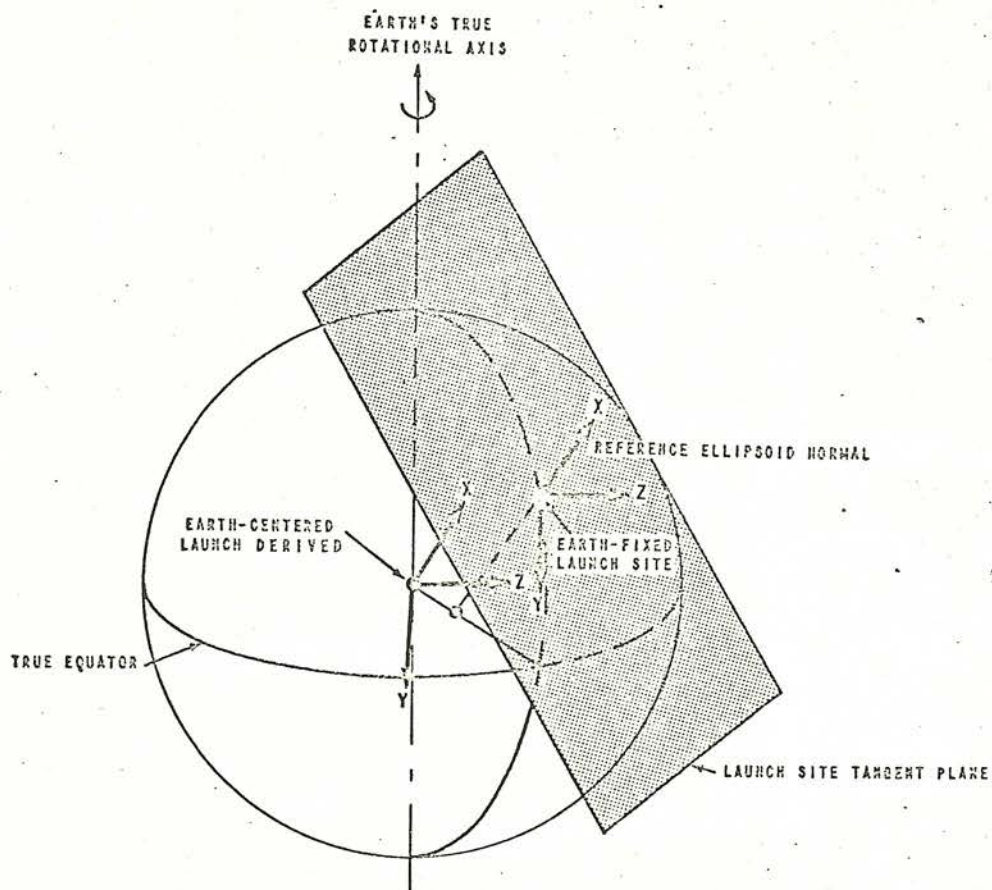

TYPE: Rotating, Earth referenced

ORIGIN: The center of the Earth

ORIENTATION AND LABELING:

The launch site tangent plane contains the site and is perpendicular to the reference ellipsoid normal which passes through the launch site.

The X axis is parallel to the reference ellipsoid normal passing through the launch site and is positive toward the launch site.

The Z axis is parallel to, and positive in the same direction as, the Earth-fixed aiming azimuth.

The Y axis completes a standard right-handed system.

(The Y-Z plane is parallel to the launch site tangent plane).

This system is translatable with the Earth-Fixed Launch Site system.

FIGURE A-11

STANDARD COORDINATE SYSTEM 12  
LAUNCH VEHICLE PLATFORM-ACCELEROMETER

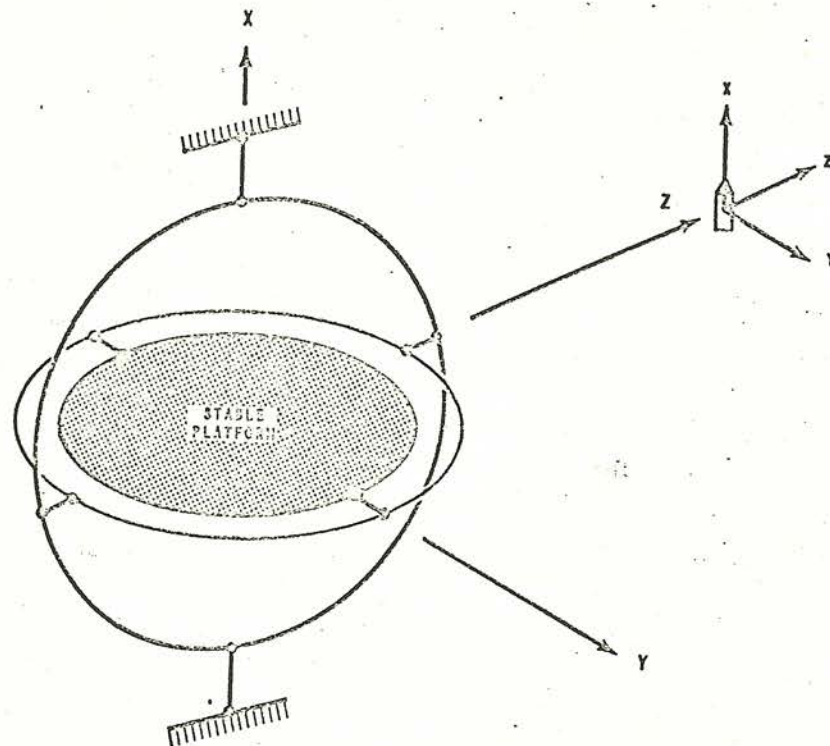

TYPE: Non-rotating, vehicle referenced

ORIGIN: The intersection of the primary axes of the accelerometer

ORIENTATION AND LABELING:

The X axis is parallel to the reference ellipsoid normal through the launch site, positive upward.

The Z axis is parallel to the aiming azimuth, positive downrange.

The Y axis completes a standard right-handed system.

This system is translatable with the Earth-Fixed Launch Site system at guidance reference release time.

FIGURE A-12

STANDARD COORDINATE SYSTEM 13  
LAUNCH VEHICLE NAVIGATION

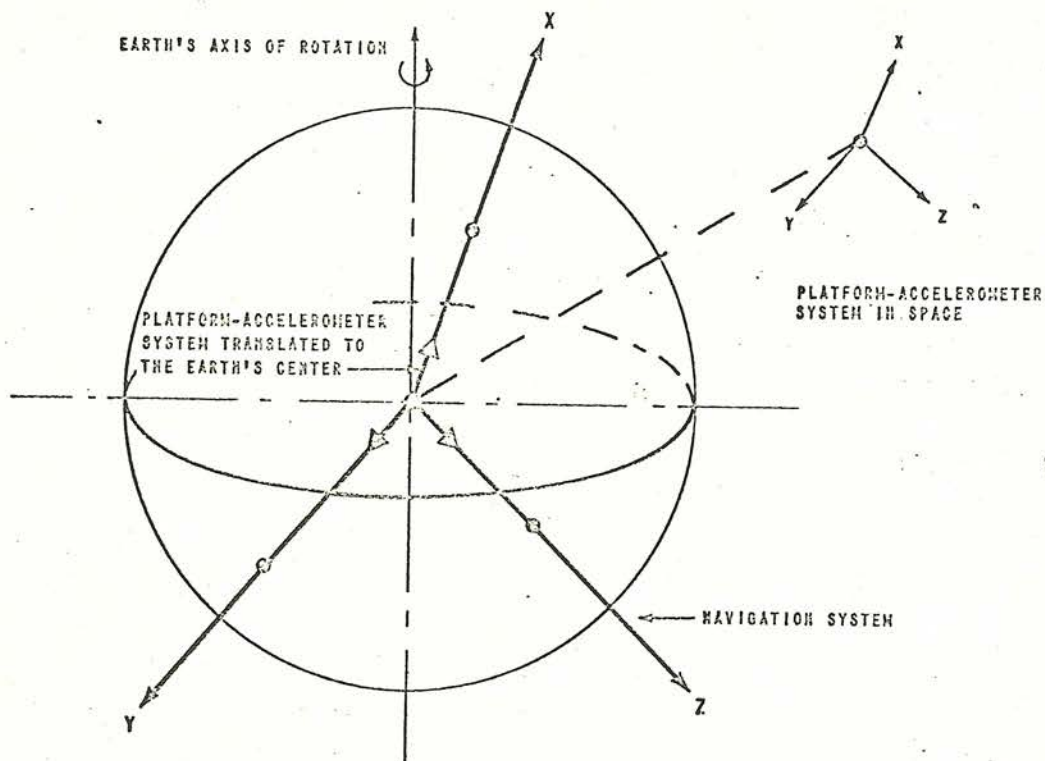

TYPE: Non-rotating, Earth referenced

ORIGIN: The center of the Earth

ORIENTATION AND LABELING:

This system is translatable from the Launch Vehicle Platform-Accelerometer system at guidance reference release for the launch vehicle.

The X axis is parallel to the X axis of the Launch Vehicle Platform-Accelerometer system.

The Y axis is parallel to the Y axis of the Launch Vehicle Platform-Accelerometer system.

The Z axis completes a standard right-handed system.

FIGURE A-13

7.

APPENDIX B

Project Apollo Standard Relationships Existing  
Among Standard Coordinate Systems

This Appendix contains the figures depicting  
the three Standard Relationships.

LIST OF PROJECT APOLLO STANDARD RELATIONSHIPS

- B-1                    Dynamical Body Axes Systems
- B-2                    The Orientation of the Launch  
Vehicle, CSM and LEM Structural  
Body Axes in the Launch Configuration
- B-3                    Space Vehicle Structural Body Axes

STANDARD RELATIONSHIP I

DYNAMICAL BODY AXES SYSTEMS

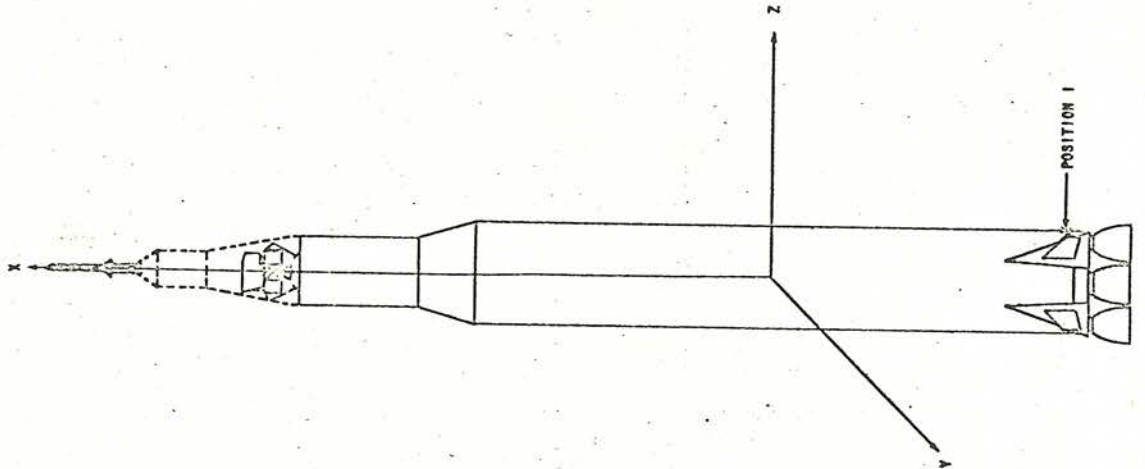

LAUNCH VEHICLE

NOTE: THE DYNAMICAL BODY AXES ARE STANDARDIZED IN THE SENSE THAT THE POSITIVE Z AXIS IS THE PREFERRED DOWN RANGE DIRECTION FOR EACH VEHICLE, WHEN OPERATING INDEPENDENTLY.

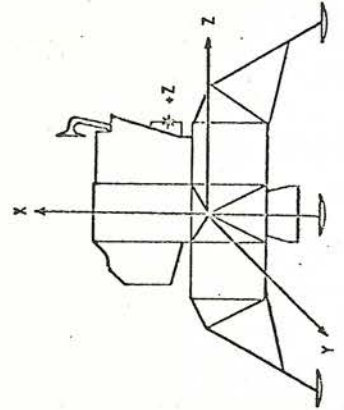

LUNAR EXCURSION MODULE

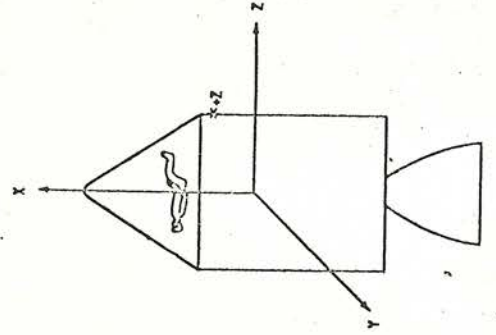

COMMAND AND SERVICE MODULE



STANDARD RELATIONSHIP 2

THE ORIENTATION OF THE LAUNCH VEHICLE, CSM AND LEM  
STRUCTURAL BODY AXES IN THE LAUNCH CONFIGURATION

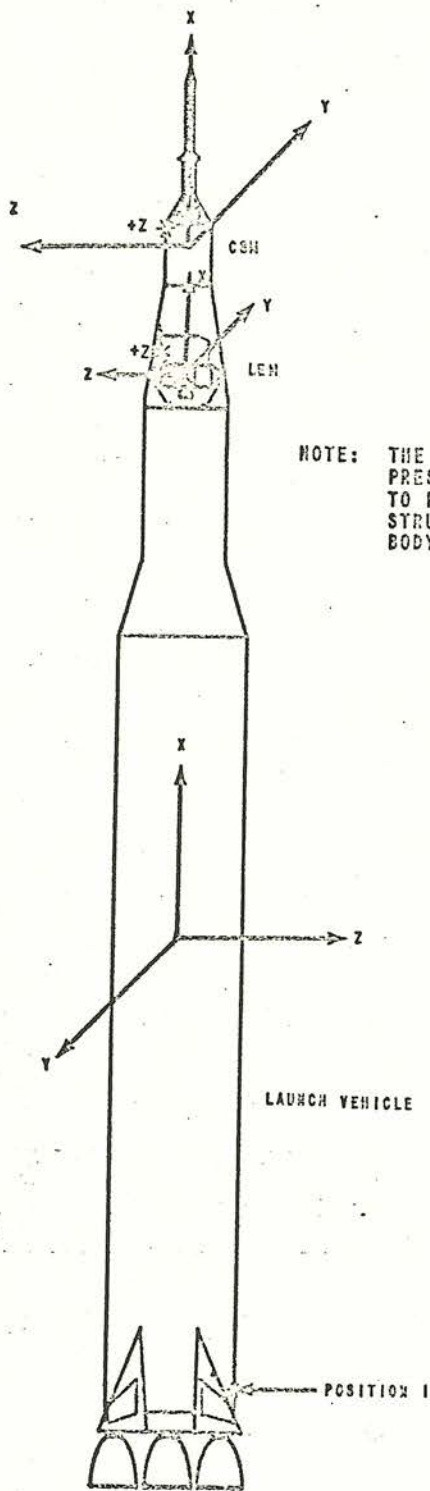
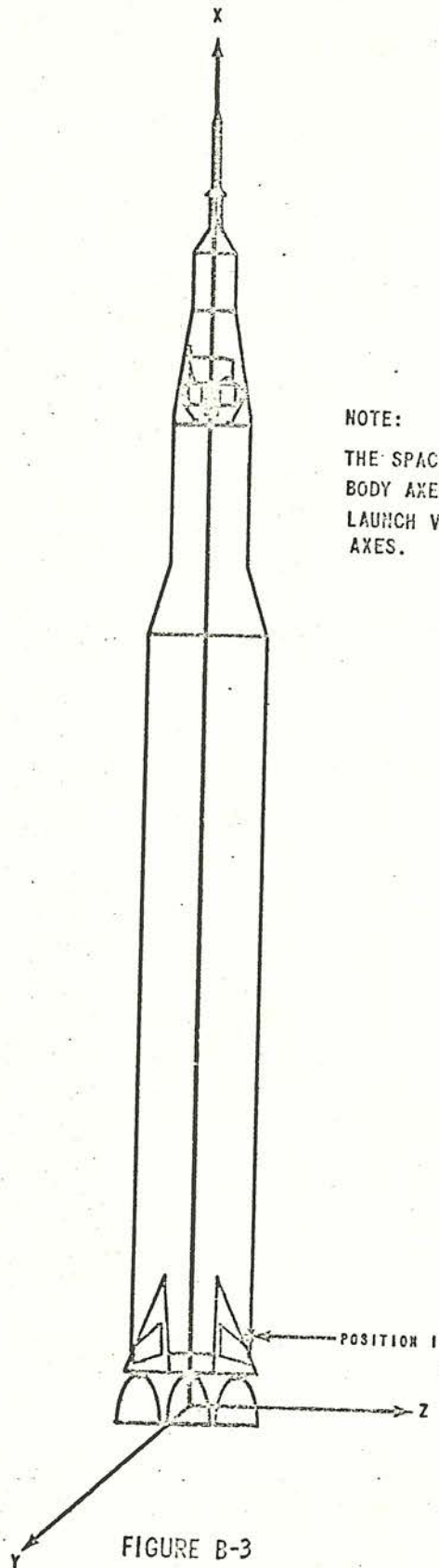

FIGURE B-2

STANDARD RELATIONSHIP 3  
SPACE VEHICLE STRUCTURAL BODY AXES



NOTE:

THE SPACE VEHICLE STRUCTURAL  
BODY AXES ARE IDENTICAL WITH  
LAUNCH VEHICLE STRUCTURAL BODY  
AXES.

FIGURE B-3

8.

REFERENCES

1. "AFMTC Standardized Theoretical Trajectory Magnetic Tape Format", Headquarters Air Force Missile Test Center, AFMTCM 80-4, January 5, 1964.
2. "Goddard Directory of Tracking Station Locations," Goddard Space Flight Center, X-544-64-176, July 1, 1964
3. "American Standard, Letter Symbols for Aeronautical Sciences", The American Society of Mechanical Engineers, (ASA Y10.7-1954), October, 1954.
4. "Recommendations of Marshall Space Flight Center for Standardization of Coordinate Systems in MSF", MSFC, NASA TM X-54182, March 2, 1965.
5. "Mass Properties Standard", NASA OMSF Program Directive, M-DE 8000.006, Effective June 1, 1963.